

SOLDERING POT

FX-305

Instruction Manual

Thank you for purchasing a HAKKO product.
This product is a soldering pot.

Make sure to read this manual before using the product, and keep it in a safe place for future reference.

1. Set contents and assembly

Main Unit FX-305 (Pot size: 75 × 75 square)	1	Software (CD-ROM)	1
Solder waste collector	1	Power cord	1
Spatula	1	Instruction manual	1
Solder pot cover	1	(this document)	1
Hexagon wrench (Size 2 mm)	1	Instruction manual	1
USB cable	1	(Quick Parameter Settings / Connecting to a Computer)	1

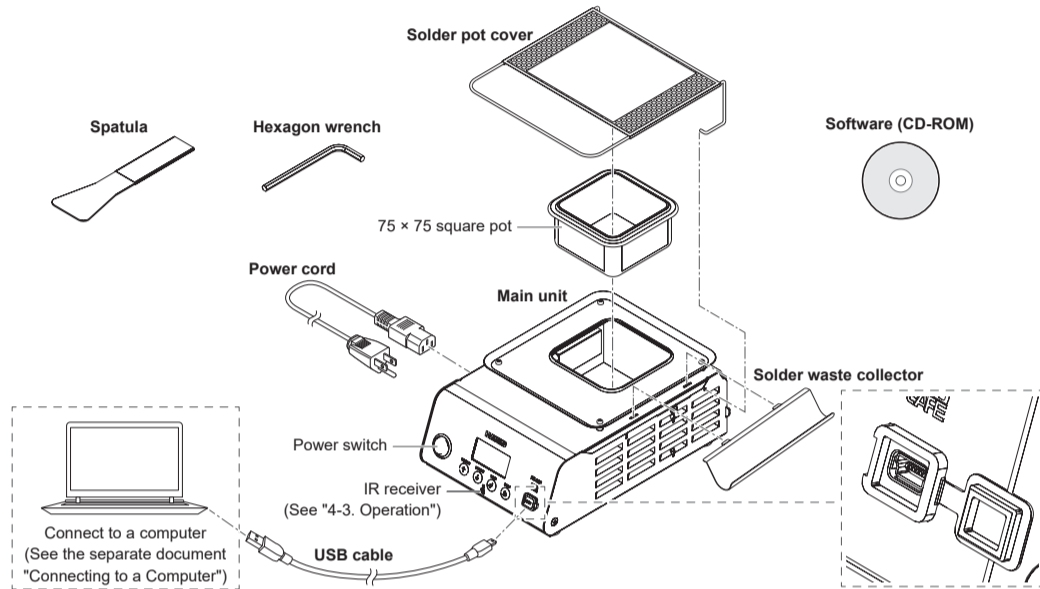

See the web page for the product information such as replacement parts/options.
https://www.hakko.com/doc_fx305-e

3. Warnings, Cautions, and Notes

Warnings, cautions, and notes are placed at critical points in this manual to direct your attention to significant items. They are defined as follows:

- WARNING:** Failure to comply with a WARNING may result in serious injury or death.
- CAUTION:** Failure to comply with a CAUTION may result in injury to the operator, or damage to the items involved.
- NOTE:** This indicates procedures or information that are important in a process described in this document.

Be sure to observe the following precautions to ensure safety.

WARNING

- This appliance can be used by children aged from 8 years and above and persons with reduced physical, sensory or mental capabilities or lack of experience and knowledge if they have been given supervision or instruction concerning use of the appliance in a safe way and understand the hazards involved.
- Children shall not play with the appliance.
- Cleaning and user maintenance shall not be made by children without supervision.
- When in use the pot and molten solder are able to reach temperatures higher than 500°C. You may risk getting burned or causing a fire if mishandled.
- Use the product on a stable metal workbench and make sure there are no flammable materials nearby.
- Do not put water into the pot. Doing so is dangerous, as it can cause solder to splatter.
- Do not touch any metal parts around the pot.
- Do not place anything that easily burns or ignites near the product.
- Make sure that people nearby are aware of the "high temperature danger."
- Disconnect the power cord and wait until the solder and pot have cooled to a safe ambient temperature before changing pots.
- When the product is not in use, being repair, or being cleaned, turn off the power switch and disconnect the plug from the power outlet.

Failure to observe the following precautions to ensure safety might result in electric shock, malfunction or other trouble.

CAUTION

- Before using this product, fully read all descriptions in this document.
- Only use the product for soldering.
- Soldering produces smoke, so make sure to work in a well-ventilated area.
- Use genuine HAKKO parts for included parts/replacement parts/options.
- Do not modify this product.
- Do not use damaged cords or plugs. Doing so can result in malfunction or injury.
- Do not use the product if it has been dropped or shows signs of damage.
- When inserting and removing the cord, hold the plug body and do not pull the cord.
- Do not allow this product to get wet. Also, do not handle it with wet hands.
- Do not perform any other actions that may be considered to be dangerous.

2. Specifications

Power consumption	550 W (100 V), 680 W (110 V), 575 W (120 V), 580 W (220 V), 640 W (230 V), 700 W (240 V)
Temperature range	50 × 50 square: 50 to 530°C (120 to 990°F) 75 × 75 square: 50 to 500°C (120 to 940°F) 100 × 100 square: 50 to 450°C (120 to 850°F)
Dimensions	Main unit only: 162 (W) × 100 (H) × 239 (D) mm (6.4 × 3.9 × 9.4 in) With solder pot cover attached: 162 (W) × 123 (H) × 239 (D) mm (6.4 × 4.8 × 9.4 in)
Weight	2.5 kg (5.5 lb)

Pot

Solder pot dimensions (inner)	50 × 50 square: 50 (W) × 42.5 (H) × 50 (D) mm (2 × 1.7 × 2 in)
	75 × 75 square: 75 (W) × 42.5 (H) × 75 (D) mm (3 × 1.7 × 3 in)
	100 × 100 square: 100 (W) × 53 (H) × 100 (D) mm (3.9 × 2.1 × 3.9 in)
Molten solder capacity	50 × 50 square: 0.85 kg (1.9 lb) 75 × 75 square: 1.9 kg (4.2 lb) 100 × 100 square: 2.75 kg (6.1 lb)

- * The weight excludes the cord.
- * This product is applied with electrostatic countermeasures.
- * The molten solder capacity is measured using Sn-Pb based solder.
- * Please note that specifications and appearance are subject to change without notice in the interest of product improvement.

CAUTION

Handling precautions for ESD Safe products

This product contains electrostatic countermeasures, so please use the following precautions:

1. Not all plastic parts are insulators, they may be conductive. Be careful not to expose live electrical parts or damage insulating materials when performing repairs or replacing parts.
2. Be sure the product is grounded before use.



HAKKO CORPORATION

HEAD OFFICE

4-5, Shiokusa 2-chome, Naniwa-ku, Osaka 556-0024 JAPAN
TEL: +81-6-6561-3225 FAX: +81-6-6561-8466
<https://www.hakko.com> E-mail: sales@hakko.com

OVERSEAS AFFILIATES

U.S.A.: AMERICAN HAKKO PRODUCTS, INC.

TEL: (661) 294-0090 FAX: (661) 294-0096
Toll Free (800) 88-HAKKO

<https://www.HakkoUSA.com> E-mail: Support@HakkoUSA.com

HONG KONG: HAKKO DEVELOPMENT CO., LTD.

TEL: 2811-5588 FAX: 2590-0217
<https://www.hakko.com.cn> E-mail: info@hakko.com.hk

SINGAPORE: HAKKO PRODUCTS PTE., LTD.

TEL: 6748-2277 FAX: 6744-0033
<https://www.hakko.com.sg> E-mail: sales@hakko.com.sg

Please access the code for overseas distributors.

https://www.hakko.com/doc_network



© 2022 HAKKO Corporation. All Rights Reserved.

2022.12
80.0981-002

4. Operation

4-1. Replacing the pot

CAUTION

Turn off the power switch and disconnect the plug from the outlet, then make sure the solder has hardened and that the pot has cooled to a safe ambient temperature before replacing the pot.

- (1) Loosen (do not remove) the two screws securing the pot with the 2 mm hexagon wrench.
- (2) Replace the pot.
- (3) Tighten the left and right screws evenly and gradually. Be sure to check that both screws are tightened.

NOTE Do not overtighten the screws. The chassis may deform, causing malfunction, or the pot may lift.

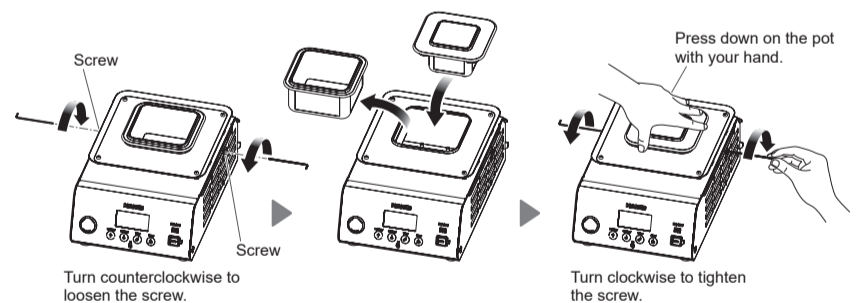

4-2. Preparations

CAUTION

When opening and closing the solder pot cover, only use the front section of the frame (see figure A). Other parts of the frame may be hot while in use.

● Use the "fixing support" (optional) when securing the product to table.

NOTE Prepare screws for securing the product to the edge of the table.

● Factory default settings are as follows:

Setting temperature 350°C
Solder type Sn-Ag-Cu
Pot size 75 × 75 square

NOTE To change the parameters, see the separate document "Quick Parameter Settings."

● Attach the solder waste collector to one side of the main unit.

NOTE When attaching the solder pot cover, you cannot attach the solder waste collector to the back.

● Attach the solder pot cover to the main unit.

NOTE For safety purposes, keep the solder pot cover closed when not working.

● Set the type of solder you will use in parameter No. 26.

Sn-Pb
Sn-Ag-Cu
Sn-Cu
Sn
Sn-Bi

Select the type that is closest to the solder you will be using.

● Set the pot size in parameter No. 27.

50 × 50 mm square
75 × 75 mm square
100 × 100 mm square

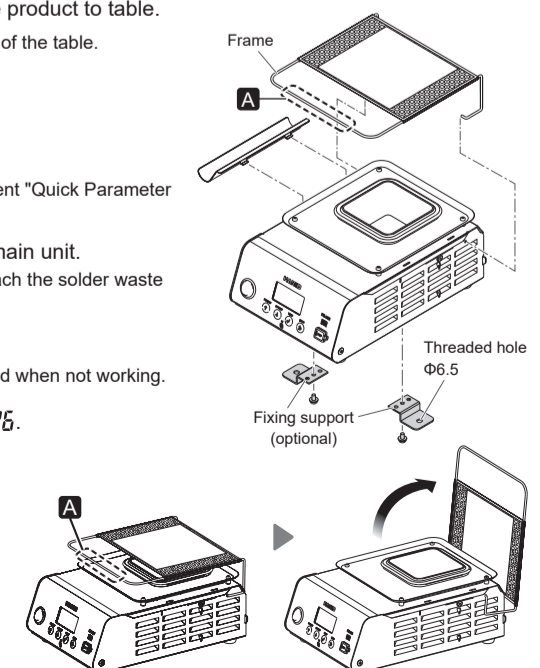

4. Operation (cont'd)

4-3. Operation

CAUTION

- Keep the solder pot cover closed until the solder is fully melted.
- The solder pot cover is very hot. Do not touch anything other than the front section of the frame.

- Turn the power on.
- Below shows what is displayed.
- Once the set temperature is reached, open the solder pot cover when ready to use.
- Keep the solder pot cover closed when not in use.

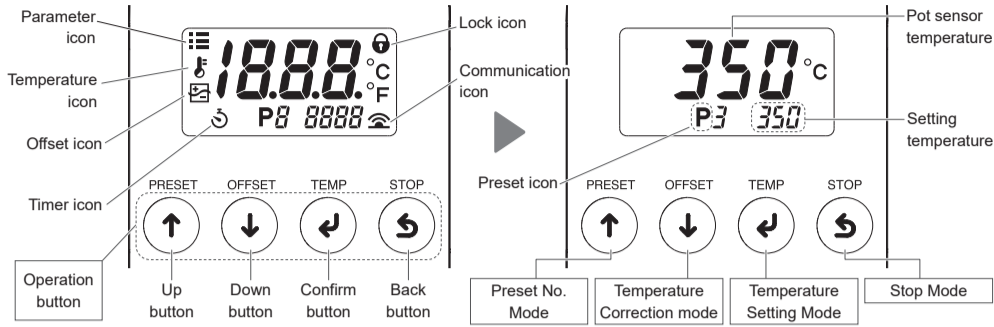

Changing the temperature setting

Push Push this button once to display and transition to "temperature setting mode." This mode is used when changing the set temperature.

To change to 400°C

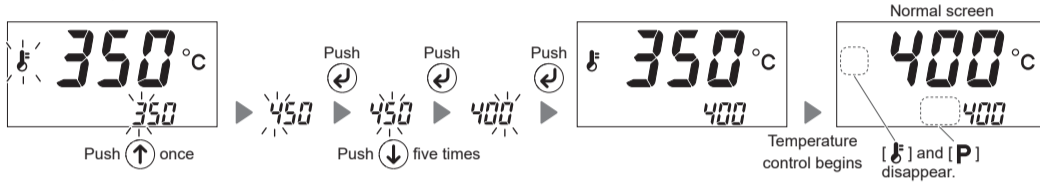

Once the normal screen appears, push the button to transition to preset No. mode.

Changing the preset No.

You can register up to five frequently used setting temperatures on the product, and then select the registration No. to change the setting temperature.

Push Push this button once to transition to "preset No. mode." Select one of the five temperatures registered in this mode. (Factory default temperature settings: P1 250°C (600°F), P2 300°C (700°F), P3 350°C (750°F), P4 400°C (800°F), P5 450°C (850°F))

NOTE The registered temperature of each preset No. can be changed in "parameter No. 23." (See the separate document "Quick Parameter Settings")

NOTE If you want to limit setting temperature changes, change the setting in "parameter No. 14." (See the separate document "Quick Parameter Settings")

5. Parameter Settings

You can change the parameter settings to suit different work environments. See the separate document "Quick Parameter Settings."

6. Maintenance

CAUTION

Use with caution, this product get hot during use.

Conducting maintenance will help keep the product in good condition and prolong the usage of the unit.

Daily maintenance

Wear and tear on the pot will vary due to the operating temperature as well as the quality and amount of solder used. Maintenance should be performed based on what suits your usage.

Setting temperature	Using the product at a temperature that is higher than necessary can accelerate pot deterioration and damage parts that are susceptible to heat. Use lowest temperature whenever possible.
Before beginning work	<p>● Pot When cool, remove the pot and visually check the following:</p> <ul style="list-style-type: none"> • Are there any holes in the pot? • Has any solder leaked onto the heat insulation plate? • Has any foreign matter collected on the heat insulation plate? <p>Make sure to change the orientation of the pot each time you remove it. Doing so can slow pot deterioration.</p>
When pausing work	Turn off the unit for long periods of unused time.

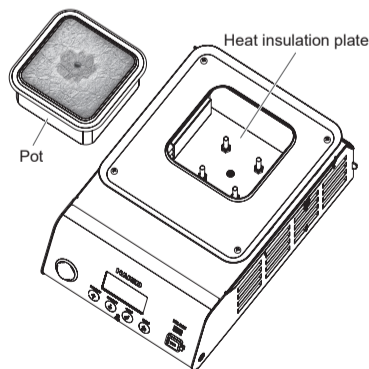

● **Solder**
Remove any oxidation or foreign matter in the molten solder using the spatula.

Internal pot temperature correction (offset)

Push Push this button once to display and transition to "temperature correction mode." If the setting temperature and measured value of the internal pot temperature differ in this mode, you can correct the temperature. (Correction range: ±100°C/±180°F)

To correct a temperature by 5°C for a setting of 400°C (to correct actual internal pot temperature reading 395°C when set to 400°C)

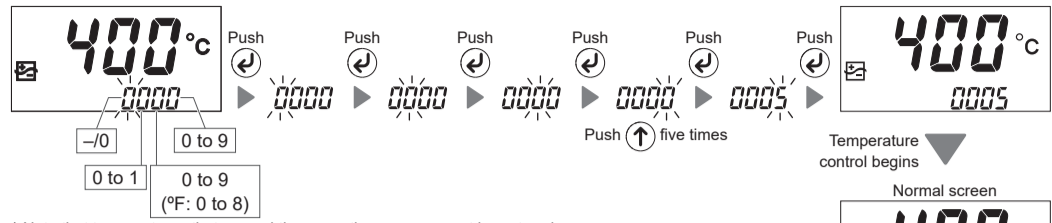

* Note that temperatures that exceed the correction range cannot be entered.

The internal pot temperature can change if it contains too many impurities. The internal pot temperature changes if you replace the pot, so the offset will need to be readjusted. Make sure to change the offset value as needed while monitoring the actual internal pot temperature.

You can automatically change the offset value using a HAKKO thermometer with a temperature sending function. Push the button before sending the measured value. (See the figure on the right)

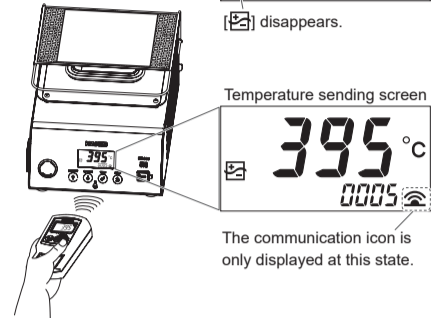

Checking the drop in temperature inside the pot (Stop mode: Heating element off)

Push Push this button once to display the confirmation screen, then push the button to confirm. This will turn off the heating elements and is used to show the pot temperature cooling to a safe level. Push the button again to turn the heaters on and return to normal operation.

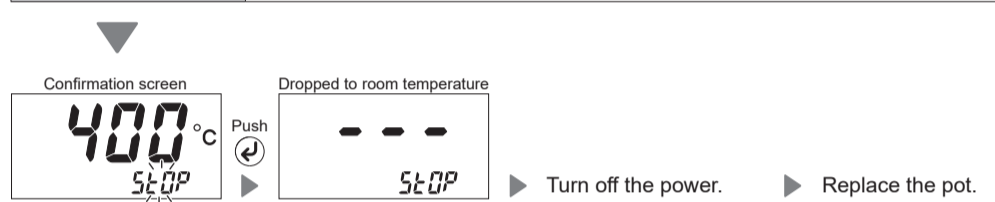

Push the button once to check the "solder type" and "accumulated pot usage time" set in the parameters. (See the separate document "Quick Parameter Settings")

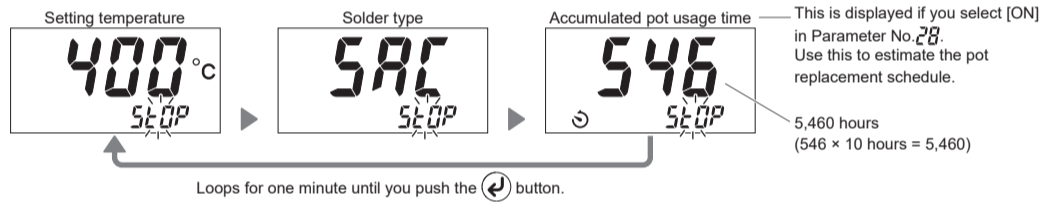

7. Troubleshooting

CAUTION

Before performing an inspection or replacing parts, make sure to disconnect the power plug from the outlet.

No operation even if power switch is turned ON.	Is the power cord connected?	▶ Connect the power cord to the main unit.
	Is the fuse blown?	▶ Replace the fuse. ▶ If the fuse is blown again, send the main unit back for service.
[L - E] is displayed.	Is there any foreign matter on the heat insulation plate located under the pot?	▶ Remove/clean any foreign matter.
	Is there any holes in the pot and has solder leaked into the interior of the main unit?	▶ Remove the solder and replace the pot.
[S - E] is displayed.	Is the heating element connected to the board?	▶ Connect it to the board.
The internal pot temperature is too high/low.	Is the offset value entered correct?	▶ Measure and adjust the value. (See "Internal pot temperature correction (offset)" in "4-3. Operation")
	Is one of the heating elements burnt out?	▶ If the resistance of the heating element is abnormal, replace it. (See "How to check the heating element resistance")
	Is the heating element connected to the board?	▶ Connect it to the board.
	Are the left and right screws securing the pot loose?	▶ Tighten both the left and right screws. (See "4-1. Replacing the pot")

If you cannot find a solution in this manual, or if another problem occurs, please contact the retailer where you purchased the product.

How to check the heating element resistance

- Disconnect the power plug from the outlet.
- Remove the pot when it is cool.
- Remove the screws and washer securing the cover.
- Open the cover.
- Disconnect the heating element connector from the board.
- Measure the resistance of the heating element when it is at room temperature. (See below for pin layout and resistance references)
- Replace the heating element if the value is abnormal.

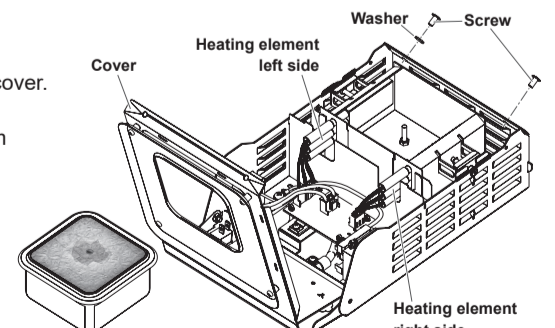

Normal resistance for heating element left side (at room temperature)

	Between pins 1 - 3	Between pins 5 - 6
100 V / 110 V	8 to 13 Ω	129 to 191 Ω
120 V	13 to 18 Ω	
220 V / 230 V / 240 V	46 to 63 Ω	

Normal resistance for heating element right side (at room temperature)

	Between pins 1 - 3
100 V / 110 V	5 to 9 Ω
120 V	9 to 12 Ω
220 V / 230 V / 240 V	31 to 42 Ω