

# & Operability Unleashes

Large Components



Medical Equipment



Industrial Equipment



Automotive Devices

The Solution in the Large Current Era

Multi-Layered P.W.B.

Outstanding Performance in Heavy-Duty Soldering

There is an increasing demand for larger current applications in industries such as automotive devices, industrial equipment, etc. The larger current requires thicker copper foil of P.W.B., more layers of P.W.B. and bigger harnesses. And because of that, the demand for soldering iron with higher thermal capacity and operability is increasing.

Thick Wire Harnesses



Communication Equipment



Air Conditioners



Energy-Related Equipment

## ◀ A Wide Range of Tip Shapes

A wide range of tip shapes is available for a variety of soldering applications. The composite tip, a soldering tip integrated with a heating element and sensor, makes its replacement easy.

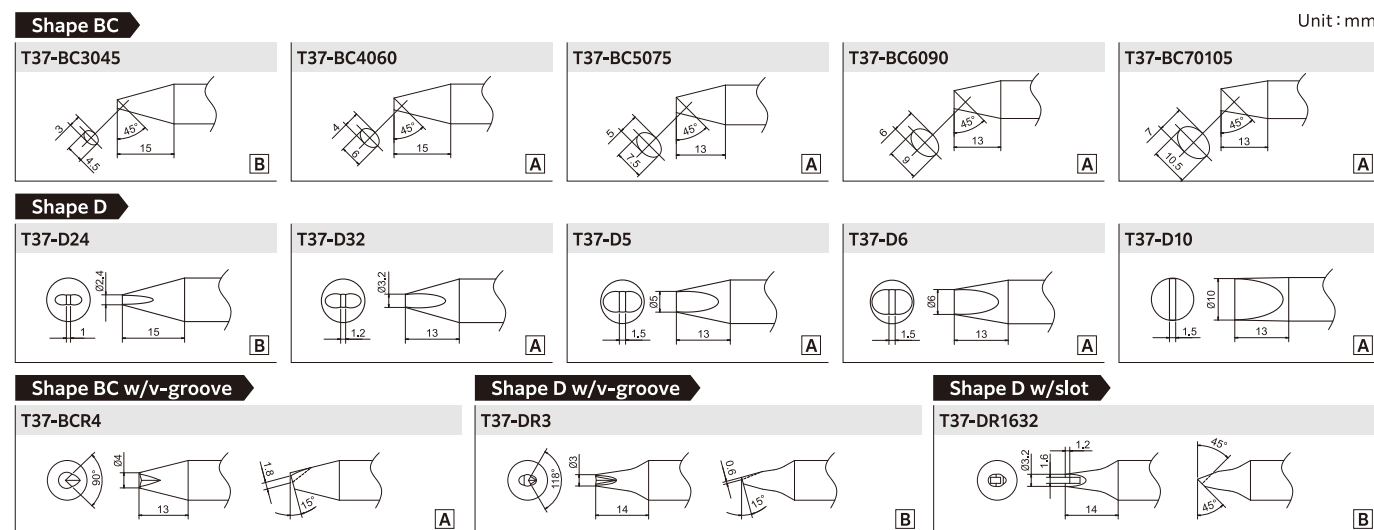

● Nozzle assembly is required for FX-8005

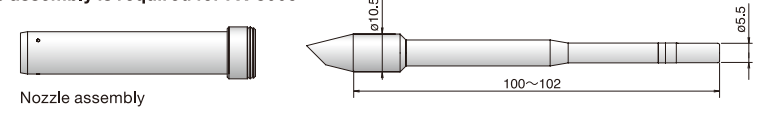

Nozzle assembly    A B5316    B B5317

## ◀ 300 W Soldering Tips Are Compatible with FX-805

FX-805 accepts not only the new T37 series (400 W) soldering tips but also the conventional T33 series (300 W). For more details, please visit our website. [https://www.hakko.com/red\\_22017](https://www.hakko.com/red_22017)



## ◀ Improving Solderability by the Heated N<sub>2</sub> Gas Option

Changing the handpiece to FX-8005 enables N<sub>2</sub> soldering. Heated N<sub>2</sub> gas discharged from the tip end helps solve insufficient heating, improve solder wetting and reduce thermal load to heat-sensitive components. For more details, please visit our website. [https://www.hakko.com/red\\_22018](https://www.hakko.com/red_22018)



### FX-805



Station, Handpiece FX-8004, Iron holder (with cleaning sponge/wire), Filter, USB cable, Power cord, Instruction manual

The dedicated software is available to download from our website.

Specifications	
Model No.	FX-805
Power consumption	460 W
Temperature range	50 to 500°C
Temperature stability	At idle temperature ±5°C
<b>Station</b>	
Output	AC 30 V
Dimensions	143 (W) x 107 (H) x 218 (D) mm
Weight	3.9 kg
<b>Handpiece</b>	
Power consumption	390 W (30 V)
Tip to ground resistance	< 2 Ω
Leak voltage	< 2 mV
Heating element	Composite heater
Cord length	1.2 m
Total length	244 mm (with T37-D24 tip)
Weight	54 g (with T37-D24 tip)

\*Total length and weight are measured without cord.

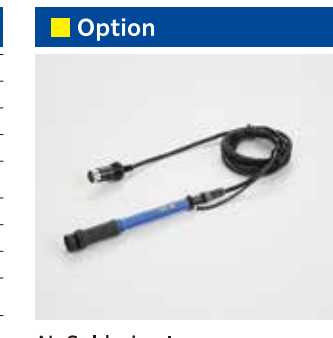

N<sub>2</sub> Soldering Iron  
Model No. FX-8005



**HAKKO CORPORATION**  
OVERSEAS AFFILIATES

U.S.A.  
AMERICAN HAKKO PRODUCTS, INC.  
28520 AVENUE WILLIAMS VALENCIA, CA 91355, U.S.A.  
TEL: (611) 294-0090 FAX: (611) 294-0096  
Toll Free (800)88-HAKKO  
<https://www.hakko.com>  
E-mail: Support@HakkoUSA.com

HEAD OFFICE  
4-5, SHIOKUSA 2-CHOME, NANIWA-KU, OSAKA, 556-0024 JAPAN  
TEL:+81-6-6561-3225 FAX:+81-6-6561-8466  
<https://www.hakko.com> E-mail:sales@hakko.com

HONG KONG  
HAKKO DEVELOPMENT CO., LTD.  
ROOM 1504, EASTERN HARBOUR CENTRE,  
28 HOI CHAK STREET, QUARRY BAY, HONG KONG.  
TEL: 2811-5588 FAX: 2590-0217  
<https://www.hakko.com.cn>  
E-mail:info@hakko.com.hk

SINGAPORE  
HAKKO PRODUCTS PTE LTD  
1, GENTING LINK #02-04  
PERFECT ONE, SINGAPORE 349518  
TEL: 6748-2277 FAX: 6744-0033  
<https://www.hakko.com.sg>  
E-mail:sales@hakko.com.sg

Please access the web address below for other distributors.  
<https://www.hakko.com>

Specifications and design are subject to change without notice.  
Copyright HAKKO Corporation. All right reserved.



Soldering Iron  
Station Type  
Heavy Duty Soldering Iron

**HAKKO FX-805** ESD SAFE  
SOLDERING STATION

The Fusion of  
**Ultra Power & Operability**  
unleashes **Heavy-Duty Soldering**



CA00567EaYa001 2022.7



# The Fusion of Ultra Power & Operability Unleashes Heavy-Duty Soldering

## The Smallest, Lightest and Best Heavy-Duty Soldering Station

HAKKO developed FX-805 to meet the demand from the fields for more powerful but more comfortable soldering stations. 400 W Ultra Power and comfortable operation by compact design provide tremendous performance.

### Ultra Power FX-805 That Melts even a Solder Bar Quickly

FX-805 with 400 W composite heater, the highest wattage in HAKKO composite tips, achieves rapid heating. It is best suited for soldering transformers or coils on power-supply boards or shield cases on communication devices.

Ultra Power  
400 W



Compact Design

### The Smallest and Lightest Heavy-Duty Soldering Model in the Industry

The Handpiece Weights Approx. 50 g

Despite its 400 W power, the handpiece is the lightest in the industry for comfortable operation. Please experience the outstanding performance.

Comfortable Operation

### For More Comfort for Less Stress

The 10%\* thinner cord makes the operation more smooth and comfortable. \*Comparison with the handpiece of FX-801 (300 W soldering station)

## The Solution in the Large Current Era

### « The New Composite Tip

The newly developed composite tip achieves 400 W Ultra Power. Its high thermal capacity improves soldering productivity to 120%\* of the conventional model.

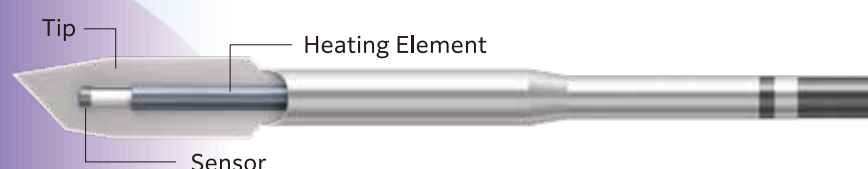

#### 1. Improved Sensor Sensitivity

The improved sensor is set close to the tip end and measures a more accurate temperature at the soldering point.

#### 2. The New Tip Design for Smoother Heat Transfer

The volume of the heater body is 113%\* of the conventional model without a change in diameter and improves thermal conductivity. \*Comparison with FX-801 (300 W soldering station)

### « Safe Tip Replacement

The new design iron holder with the tip removing attachment makes tip replacement safe and easy.

#### The New Design Iron Holder

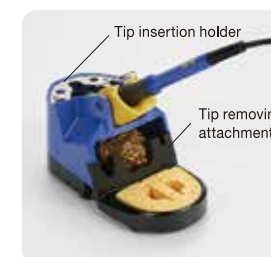

Removing a tip with the right groove of the attachment

Safe tip insertion by using the tip insertion holder

### « Traceability in Manual Soldering

The dedicated software\* automatically records set temperature, calibration /offset, and tip sensor temperature in soldering. It prevents human error in such recording. \*PC is required and must be connected with the station.

#### Digital Management



The recorded data are available for search and browse.

### « Human Error-Free Operation

Using the thermometer (FG-100B/FG-101B) along with FX-805 enables automatic calibration/offset function. It helps prevent human error by eliminating the manual recording process.

### « PICK UP New Additional Tip Shapes

#### For Large Components 10 mm wide tip

T37 series has a 10 mm wide tip in the lineup, which maximizes the performance of 400 W power. This tip is recommended for soldering large components with high thermal mass and thick wire harnesses.

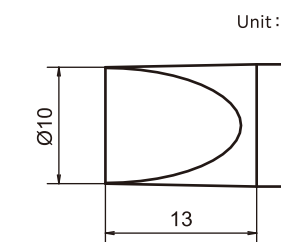

Part number: T37-D10

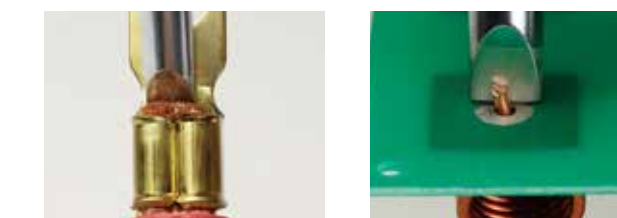

#### For Through-Hole Fill Tip with V-groove

The V-groove on the tip increases the contact area with land and component lead. As a result, it effectively transfers heat and improves through-hole fill, soldering quality, and productivity.

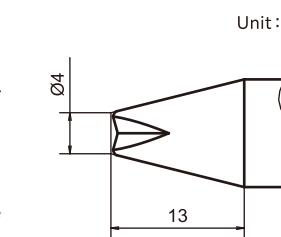

Part number: T37-BCR4



For more details, please visit our website. [https://www.hakko.com/red\\_22015](https://www.hakko.com/red_22015)

