

## オプション / 另購配件 / Optional parts

使用後は必ずスライドボタンを“ I ”に切り換えて90秒以上クールダウンしてください。

使用后，請務必將滑動按鈕切換到 “I” 後冷卻90秒以上。

After use, always turn the slide button (switch) to "I" and allow the unit to cool down for at least 90 seconds.

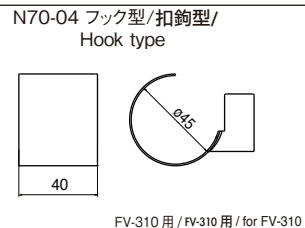
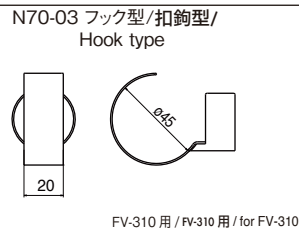
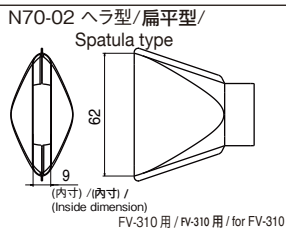
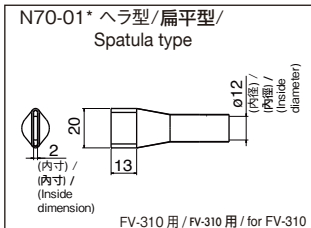

\* 温度ヒューズが切れる恐れがありますので、温度調節ツマミが5、風量調節ツマミが2以下の条件でご使用された後は必ずクールダウンを行なってください。

\* When the unit is used under the condition below, ALWAYS cool down after use. Failure to follow this procedure may result in blown fuse.  
Temperature control knob: level 5 Air flow control knob: level 2 or lower

\* 高溫可能會導致溫度保險絲發生熔斷，所以當溫度調節旋鈕設定為5，且風量調節旋鈕設定為2以下的狀態使用后，請務必進行冷卻。

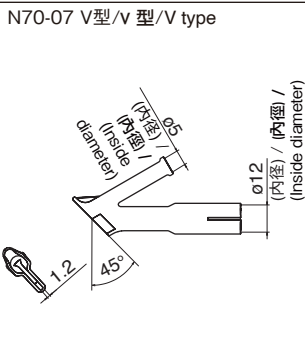
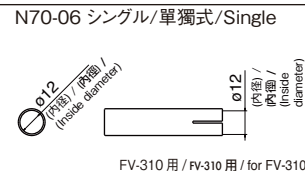
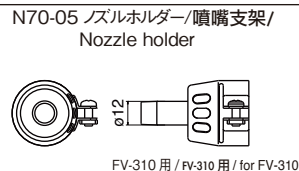

**HAKKO**  
HAKKO CORPORATION  
HEAD OFFICE

4-5, Shioikusa 2-chome, Naniwa-ku, Osaka 556-0024 JAPAN  
TEL: +81-6-6561-3225 FAX: +81-6-6561-8466  
<https://www.hakko.com> E-mail: [sales@hakko.com](mailto:sales@hakko.com)

**OVERSEAS AFFILIATES**  
U.S.A.: AMERICAN HAKKO PRODUCTS, INC.  
TEL: (661) 294-0090 FAX: (661) 294-0096  
Toll Free (800) 88-HAKKO  
<https://www.HakkoUSA.com> E-mail: [Support@HakkoUSA.com](mailto:Support@HakkoUSA.com)  
HONG KONG: HAKKO DEVELOPMENT CO., LTD.  
TEL: 2811-5588 FAX: 2590-0217  
<https://www.hakko.com.cn> E-mail: [info@hakko.com.hk](mailto:info@hakko.com.hk)  
SINGAPORE: HAKKO PRODUCTS PTE., LTD.  
TEL: 6748-2277 FAX: 6744-0033  
<https://www.hakko.com.sg> E-mail: [sales@hakko.com.sg](mailto:sales@hakko.com.sg)

**HAKKO**

白光株式会社  
<https://www.hakko.com>

〒556-0024 大阪市浪速区塩草2丁目4番5号  
TEL: (06) 6561-1574 (日) FAX: (06) 6568-0821

Please access the web address below for other distributors.  
<https://www.hakko.com>

© 2016-2021 HAKKO Corporation. All Rights Reserved.

MA02883XZ210726