



# **HAKKO 941** SOLDERING STATION

High-output, temperature controlled  
compact soldering station

## **Instruction Manual**



Thank you for purchasing the Hakko 941 soldering station. This high-output, temperature controlled compact soldering station uses a composite tip, incorporating heater and sensor functions into one element. Several process control features, unique to the Hakko 941, make it applicable to a broad range of soldering applications.

Please read this manual before operating the Hakko 941. Keep this manual readily accessible for reference.



### **TABLE OF CONTENTS**

1. PACKING LIST .....	1
2. SPECIFICATIONS .....	1
3. WARNINGS, CAUTIONS, NOTES AND EXAMPLES .....	2
4. PART NAMES .....	3
5. INITIAL SETUP .....	3
6. OPERATION .....	5
7. ENTERING TIP OFFSET VALUES .....	8
8. PARAMETER SETTINGS .....	10
9. MAINTENANCE .....	12
10. ERROR MESSAGES .....	14
11. TROUBLE SHOOTING GUIDE .....	15
12. PARTS LIST .....	16
13. TIP STYLES .....	18
14. WIRING DIAGRAM .....	19

# 1. PACKING LIST

Hakko 941 soldering station .....	1	Tip tray .....	1
Hakko 911 soldering iron .....	1	Cleaning sponge .....	1
Power cord .....	1	Instruction manual .....	1
Control card .....	1	Card chain .....	1
Heat resistant pad .....	1	Tips (not included)	
Iron holder .....	1		

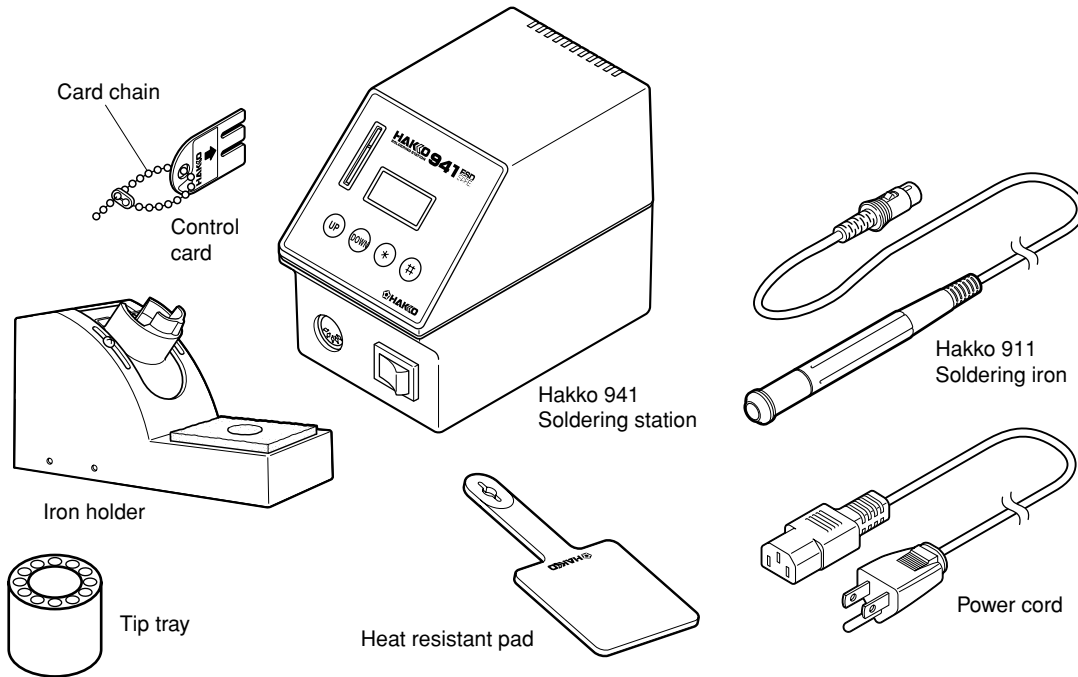

# 2. SPECIFICATIONS

## • Hakko 941 soldering station

Power consumption	50 W. total
Temperature range	200° – 450°C. (400° – 840°F.)
Temperature stability	±2.5°C. (±5°F.) at idle temperature See Figure 1.

## • Station

Output	15 V., 3 A.
Dimensions (l x w x h)	145 x 85 x 108 mm. (5.7 x 3.3 x 4.3 in.)
Weight	1,300 g. (2.9 lb.)

## • Hakko 911 soldering iron

Power consumption	45 W. (15 V.)
Tip to ground resistance	< 2 Ω
Tip to ground potential	< 2 mV.
Length, less cord	172 mm. (6.8 in.) with 2.4D tip
Weight, less cord	30 g. (0.067 lb./1.07 oz.) with 2.4D tip
Length of cord	1.2 m. (4 ft.)

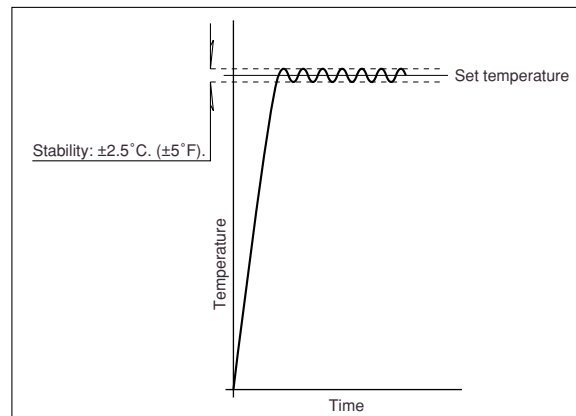



Figure 1. Temperature stability

### NOTE:

The temperatures were measured using the Hakko 191 thermometer.  
This product is protected against electrostatic discharge.  
Specifications and design are subject to change without notice.

### **3. WARNINGS, CAUTIONS, NOTES AND EXAMPLES**

Warnings, cautions and notes are placed at critical points in this manual to direct the operator's attention to significant items. They are defined as follows:

 **WARNING:** Failure to comply with a WARNING may result in serious injury or death.

 **CAUTION:** Failure to comply with a CAUTION may result in injury to the operator, or damage to the items involved. Two examples are given below.

**NOTE:** A NOTE indicates a procedure or point that is important to the process being described.

**EXAMPLE:** An EXAMPLE is given to demonstrate a particular procedure, point or process.

#### **CAUTION**

When power is ON, tip temperatures will be between 200° and 450°C. (392° to 840°F.) To avoid injury or damage to personnel and items in the work area, observe the following:

- Do not touch the tip or the metal parts near the tip.
- Do not allow the tip to come close to, or touch, flammable materials.
- Inform others in the area that the unit is hot and should not be touched.
- Turn the power off when not in use, or left unattended.
- Turn the power off when changing parts or storing the Hakko 941.

#### **CAUTION**

To prevent accidents or damage to the Hakko 941, be sure to observe the following:

- Do not use the Hakko 941 for applications other than soldering.
- Do not allow the Hakko 941 to become wet, or use it when hands are wet.
- Do not modify the Hakko 941.
- Use only genuine Hakko replacement parts.
- Do not bend or damage the control card. If the card does become damaged, do not force the card into the station slot.
- Do not strike the iron against hard objects to remove excess solder. This will damage the iron.
- Remove power and iron cords by holding the plug – not the wires.
- Be sure the work area is well ventilated. Soldering produces smoke.
- The Hakko 941 is not intended for use by children or infirm persons without supervision.
- Children should be supervised to ensure that they do not play with the Hakko 941.

**Note:** The model Hakko 941 station is not available for sale or use in the United States.

# 4. PART NAMES

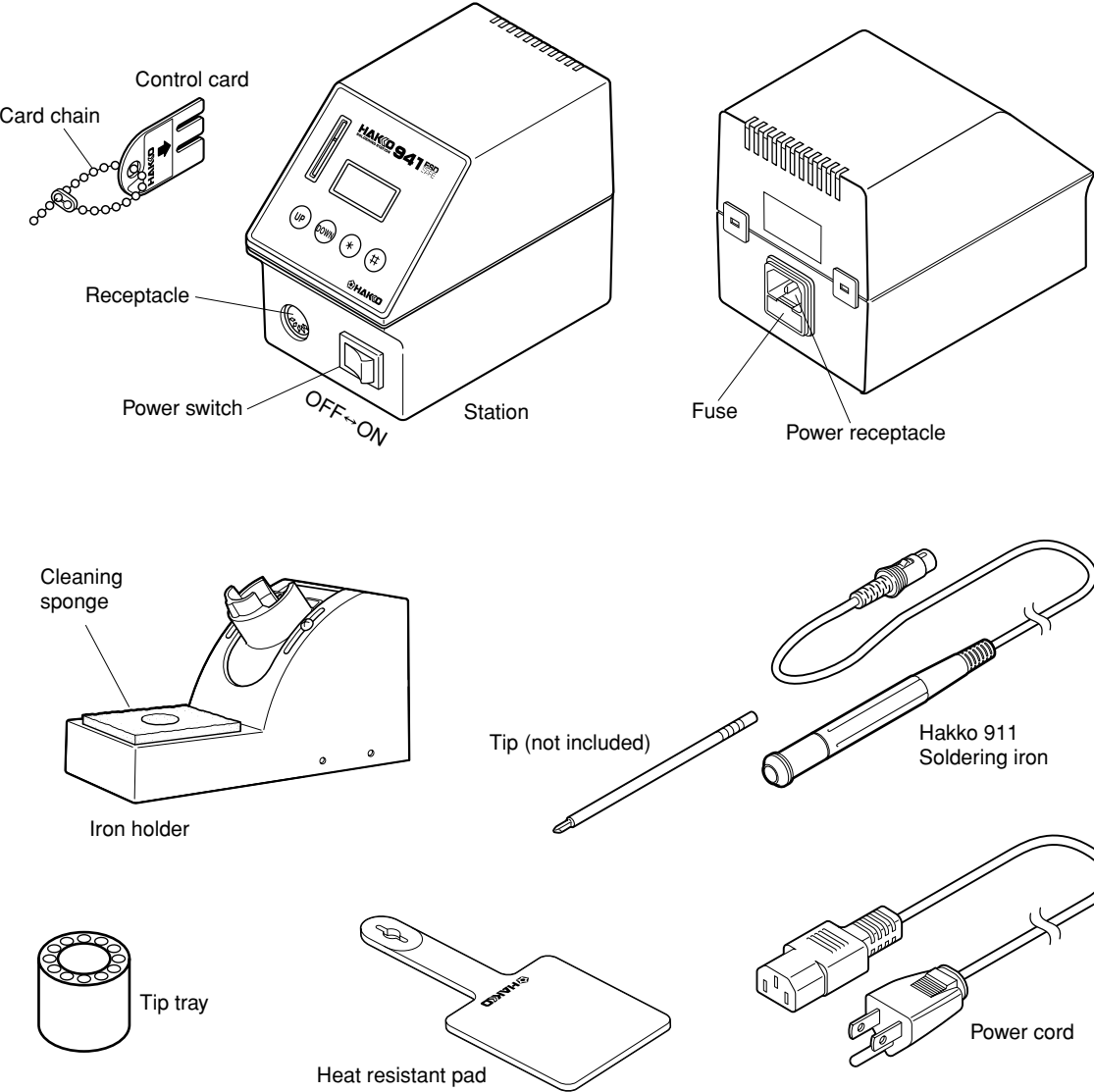

# 5. INITIAL SETUP

## A. Iron holder

1. Adjust the height of the iron holder to suit, as follows:
  - i. Loosen the adjusting screws.
  - ii. Set the iron holder to the desired height.
  - iii. Tighten the screws.

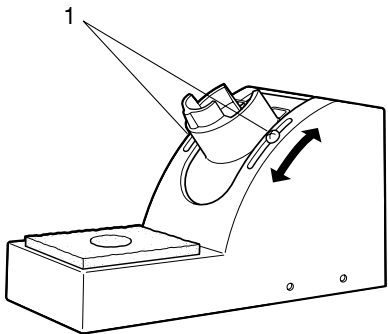

2. Put the small cleaning sponge in one of the four holes in the iron holder base.
3. Add water to the level shown in the accompanying illustration. The small sponge will keep the large sponge moist through capillary action.
4. Wet the large cleaning sponge, squeeze it dry, and put it on the iron holder base.  
     Procedure 2-4 – OR –  
     Wet the large cleaning sponge, squeeze it dry, and put it on the iron holder base.
5. Place the spare tips in the tip tray.

**NOTE:**

Be sure the cleaning sponge is kept CLEAN and DAMP. A dirty sponge will transfer contaminants to the soldering tip, reducing thermal efficiency and possibly causing defective solder joints. A dry sponge will abrade the soldering tip, reducing its life.

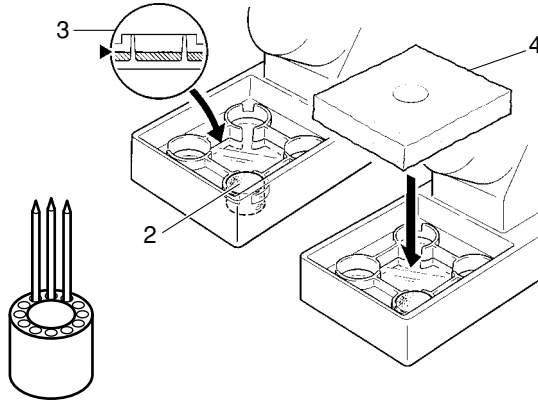

## B. Handpiece

1. Insert the tip fully into the handpiece (Hakko 911).  
     There are no orientation requirements.
2. Pass the iron cord through the hole in the heat resistant pad.

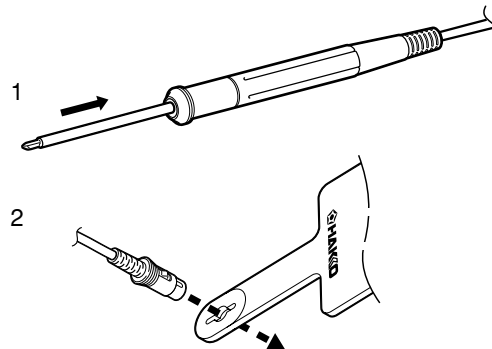

## C. Soldering station

**⚠ CAUTION:**

Be sure the power switch is OFF before connecting or disconnecting the soldering iron cord. Failure to do so may result in damage to the circuit board.

1. Insert the power cord into the receptacle at the back of the station.  
     Insert the soldering iron cord into the receptacle at the front of the station.
2. Set the iron in the iron holder.
3. Plug the power cord into a grounded wall socket. The Hakko 941 is protected against electrostatic discharge and must be grounded for full efficiency.

When the plug 'clicks', it is fully inserted.

Receptacle

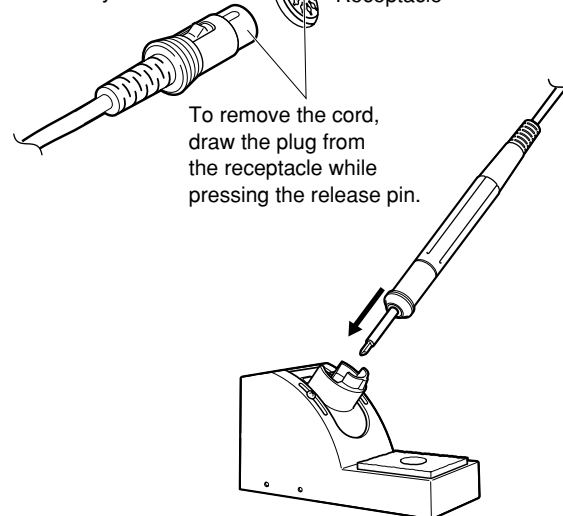

# 6. OPERATION

## Controls and displays

### Controls



The front panel of the Hakko 941 soldering station has the following controls:

- A power on/off switch.
- Four control buttons:
  - **#** – Initiates a data entry mode.
  - **\*** – End of sequence signal (terminates a phase of a data entry mode); when pressed for less than one second, displays settings already stored.
  - **UP** – increases the value in the appropriate display window.
  - **DOWN** – decreases the value in the appropriate display window.

1. Turn the power switch ON.
2. Once the temperature is reached, the buzzer sounds. The heater lamp at the lower right of the temperature display **350** starts blinking.
3. If the offset value is not 0°C./0°F., enter the tip offset value following the instructions on page 8.

**CAUTION:**  
Place the iron in the iron holder when not in use.

### Displays

The Hakko 941 has a three-digit display element. Depending upon the selected mode, it will display:

- Normal mode:
  - Sensor temperature (tip temperature)
- Data entry:
  - Selected quantity (see 'data entry procedures' for exact characteristics)
- Temperature scale:
  - °C or °F, depending upon selection
- Error detection:
  - Refer to 'ERROR MESSAGES' section

In addition, a single heater lamp will flash when the station has reached the desired temperature, indicating that it is ready for use.

An audible buzzer is provided to alert the operator when:

- The station has reached the set temperature. The buzzer will sound once.
- The low temperature threshold has been crossed. This buzzer will shutoff when the sensed temperature returns to the acceptable range.
- A failure has occurred in the sensor or heater (including the sensor circuit). The buzzer will sound continuously.
- The auto power shutoff is activated and the power to the heating element is shutoff, the buzzer will sound three times.

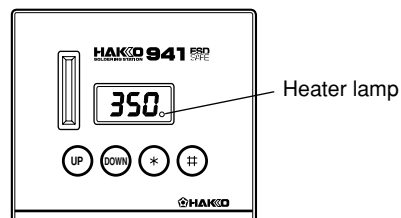

**CAUTION:**  
The Hakko 941 is preset at 350°C. at the factory. Check the temperature setting by pressing the **\*** button. The set temperature will be displayed for two seconds.

## ● Factory settings

The Hakko 941 comes from the factory with the following values preset:

Temperature scale	Celsius
Auto power shutoff	disabled
Low temperature alarm setting	150°C.
Resetting the supervisor/ operator control setting	4 0
Set temperature	350°C.

## ● Control card

Each Hakko 941 comes with a small card, which inserts in the control slot in the front of the unit. This card is used when entering data for the process control functions. Any Hakko 941 card can be used with any Hakko 941 soldering station.

### Using the control card

The control card is used when a value is to be changed or data are to be entered. The Hakko 941 will operate normally with the card inserted. If power is turned on with the card inserted, the station will heat to the temperature set before the card was inserted.

## ● Changing the temperature setting

*Example: 350° to 400°*

### 1. Insert the control card into the slot in the front of the unit.

- The *hundreds* digit will begin to flash, indicating that the unit is in the TEMPERATURE SET mode and data may be entered.

### 2. Entering the *hundreds* digit

- Press the **UP** or **DOWN** button to set the desired figure. **Only 2, 3, or 4 can be selected.** (In °F mode, 4, 5, 6, 7, or 8 can be selected).  
When the desired figure is displayed, press the **ENTER** button to enter. The *tens* digit will begin to flash.

**CAUTION:**  
The card must be inserted into the card slot in the correct direction. The heater is off while you are setting the temperature.

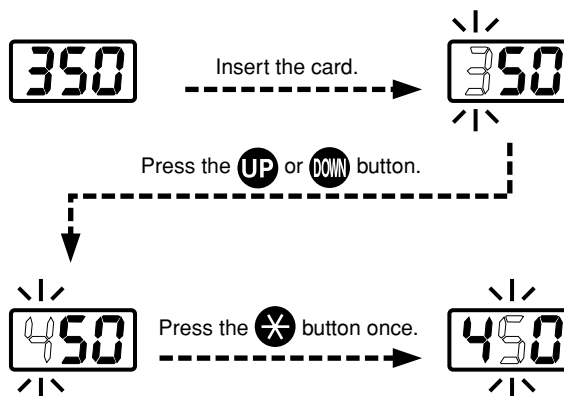

### 3. Entering the *tens* digit

- Press the **UP** or **DOWN** button to set the desired figure. **Any value from 0 to 9 can be selected.** When the desired figure is displayed, press the **✳** button to enter. The *units* digit will begin to flash.

### 4. Entering the *units* digit

- Press the **UP** or **DOWN** button to set the desired figure. When the desired figure is displayed, press the **✳** button to enter. The desired temperature is now entered into the system memory and heater control will begin.

**NOTE:**

If power is switched off or lost during the execution of this procedure, no data will be entered. The entire procedure must be repeated from step 1.

**When the station is ON and the card is in the station, the data entry procedure follows:**

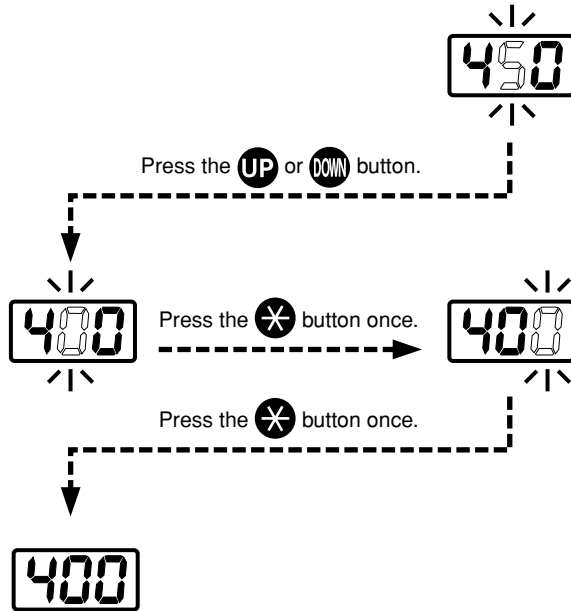

- a. Hold the **✳** button down for at least one second.
- b. The current temperature setting will be displayed, then the *hundreds* digit will begin to flash. This indicates that the station has entered the temperature setting mode.
- c. Continue with the procedure of 1-4, above.

**NOTE:**

When the **✳** button is pressed for less than one second, the current temperature setting is displayed.

## ● Replacing the tip

- a. Always turn the power OFF when removing or inserting a tip.
- b. Hold the tip with the heat resistant pad and pull it out.
- c. Insert the new tip fully into the Hakko 911. If the tip is not fully inserted, the display will show a sensor error **5-E** when power is turned on.

**CAUTION:**

The tip will be **HOT!** Use the heat resistant pad to remove it. Do not hold the tip with the heat resistant pad for an extended time.



# 7. ENTERING TIP OFFSET VALUES

Soldering tips have different thermal characteristics, depending upon their mass, shape, and surface area. It is obvious that the tip temperature at idle will not be the same for a fine tip as it will be for a heavy chisel tip, although the set temperature may be the same for each tip. The difference between the set temperature and the temperature measured at the tip is called 'Tip Temperature Offset'. Each Hakko 941 tip style has a specified offset value, which may be entered into the station to either add to or subtract from the set value, thus producing the desired tip temperature. Please refer to the tip styles and offset values on the separate sheet.

The Hakko 941 has the ability to electronically compensate for the variations due to tip temperature offset. When a soldering tip is changed, the proper offset temperature value should be programmed into the 941.

There are two methods for programming this function:

Method 1: Using the manufacturer's predetermined offset value.

Method 2: Using a tip temperature thermometer to measure the actual tip temperature.

## ● Method 1. How to enter the tip offset value into the Hakko 941

### 1. Insert the control card into the slot in the station.

- The station will default to the temperature setting mode. Set the temperature at 400°C. (750°F).

### 2. Press the **#** button on the front panel and hold for one second.

- The station will sequence to the tip temperature offset data entry mode, and the *hundreds* digit will blink 0 or -.

### 3. Entering the *hundreds* digit

- Refer to the Tip Styles and Offset Values on the separate sheet. The offset value is indicated below the tip part number. Record this value for reference.
- Press the **UP** or **DOWN** buttons to select either positive (0 is displayed) or negative (- is displayed) sign for the offset to be entered.
- Press the **\*** button. The *tens* digit will flash, indicating that the value can be changed (data may be entered).

### 4. Entering the *tens* digit

- Press the **UP** or **DOWN** button to enter the *tens* place digit of the offset value being entered. If the value displayed is correct, go to the next step.

(Example) When the offset value is -10°C.

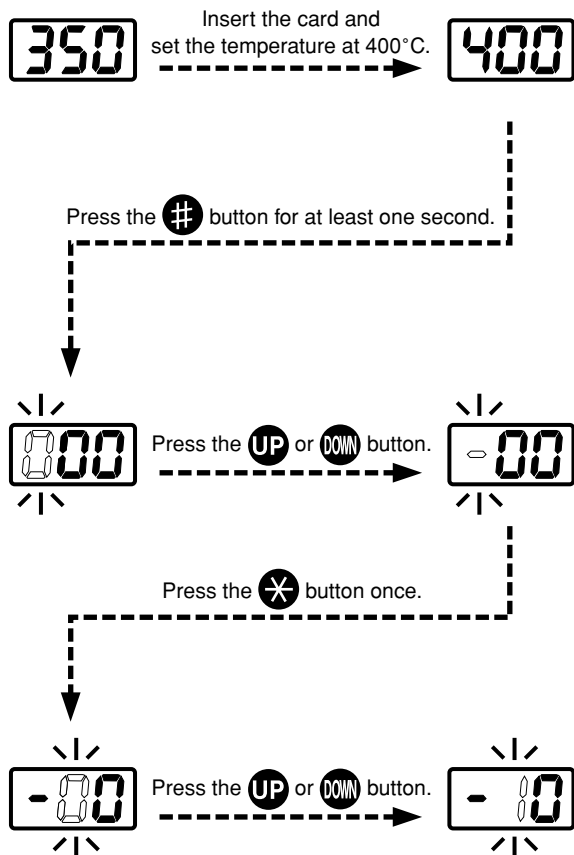

- Press the **✖** button. The *units* digit will flash, indicating that the value can be changed (data may be entered).

#### 5. Entering the *unit* digit

- Press the **UP** or **DOWN** button to enter the *units* place digit of the offset value being entered. Press the **✖** button. The tip offset data are entered into memory, the station switches to normal operation, and temperature will be controlled using the entered value.

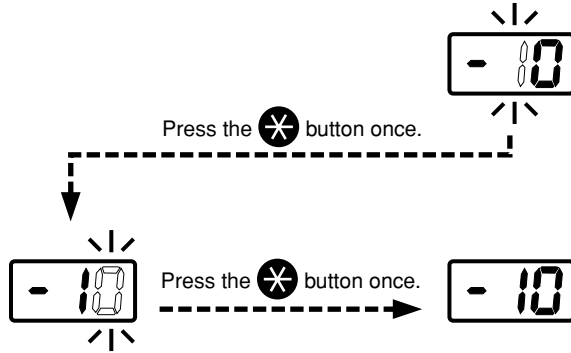

**NOTE:**

The allowable ranges for offset values are:  $-50^{\circ}$  to  $+50^{\circ}\text{C}$ .;  $-90^{\circ}$  to  $+90^{\circ}\text{F}$ . If a value outside these ranges is entered, the *hundreds* digit will blink, indicating that the system has reverted to the beginning of the mode and the procedure must be repeated from the beginning.

## ● Method 2. How to enter the tip offset value into the Hakko 941

This method requires measuring the tip temperatures with a tip thermometer and is recommended for the most accurate process control.

### 1. Insert the control card into the slot in the station.

- The station will default to the temperature setting mode. Set the temperature at  $400^{\circ}\text{C}$ . ( $750^{\circ}\text{F}$ ).

### 2. Press the **#** button on the front panel and hold for one second.

- This will set the station to the data entry mode. The existing offset will be displayed.

### 3. Measure the tip temperature.

**NOTE:**

Allow the tip temperature to become stable. During offset data entry mode, the tip temperature is controlled using an offset value of 0. The flashing value displayed is not meaningful.

### 4. Enter the offset value

- Determine the difference, if any, between  $400^{\circ}\text{C}$ . ( $750^{\circ}\text{F}$ .) and the measured tip temperature. Record this value. See the example following to determine what value to enter as the offset for that particular tip.
- Enter the actual offset value into system memory by following the procedure given for Method 1, above.

**EXAMPLE:**

If the measured temperature is  $395^{\circ}\text{C}$ . ( $740^{\circ}\text{F}$ .), the difference between the set temperature is  $+5^{\circ}\text{C}$ . ( $+10^{\circ}\text{F}$ .) (the tip is five (ten) degrees too cool) and the offset is thus  $+5^{\circ}\text{C}$ . ( $+10^{\circ}\text{F}$ .). If the measured temperature is  $405^{\circ}\text{C}$ ./ $760^{\circ}\text{F}$ ., the difference between the set temperature is  $-5^{\circ}\text{C}$ . ( $-10^{\circ}\text{F}$ .) (the tip is five (ten) degrees too hot) and the offset is  $-5^{\circ}\text{C}$ . ( $-10^{\circ}\text{F}$ .).

# 8. PARAMETER SETTINGS

## ● Entering the parameters

### (1) °C or °F temperature display

### (2) Auto power shutoff

This is an optional setting. When it is activated and the soldering iron is not used for 30 minutes, the power to the heating element is shutoff automatically and the buzzer will sound three times. When the temperature decreases to 100°C./200°F. the display will show **[ - - ]**. To begin soldering, cycle the power switch OFF, then ON. The power will be turned on if you hit any button before the temperature decreases to 100°C./200°F.

To bypass this procedure and continue to resetting the low temperature alarm tolerance setting press the **[ \* ]** button once.

The Hakko 941 has the following three parameters:

- 1) °C or °F temperature display selection
- 2) Auto power shutoff
- 3) Low-temperature alarm tolerance setting
- 4) Resetting the supervisor/operator control setting

Once the station enters parameter mode, set the parameters in the order shown below. After all the parameters have been set, normal operation will be resumed.

1. Turn power OFF.
2. Insert the control card into the card slot in the front of the unit.
3. Press and hold down the **[ UP ]** and **[ DOWN ]** buttons simultaneously, and then turn power ON.
4. Hold **[ UP ]** and **[ DOWN ]** buttons down until the display shows **[ 1 C ]** (Celsius) or **[ 1 F ]** (Fahrenheit).  
When either the display shows either **[ 1 C ]** or **[ 1 F ]**, the station is in parameter input mode.
  - Pressing either the **[ UP ]** and **[ DOWN ]** button will cause the display to alternate between **[ 1 C ]** or **[ 1 F ]**.
  - When the desired scale is displayed, select by pressing the **[ \* ]** button. The system will automatically sequence to auto power shutoff mode.

To change the auto power shutoff setting, the procedure is as follows.

- The display will show **[ 2 1 ]** or **[ 2 0 ]** when this mode is entered.
- Using **[ UP ]** or **[ DOWN ]** button will change **[ 2 1 ]** and **[ 2 0 ]**.  
The auto power shutoff is operational only when **[ 2 1 ]** is selected.
- Press the **[ \* ]** button to enter the parameter. This will store the auto power shutoff setting in system memory. The system will automatically sequence to the low temperature alarm tolerance setting.

#### ⚠ CAUTION:

It is possible that the auto power shutoff function could be activated, shutting off the heating element even though soldering is being done, if the thermal load is very small. Should this occur, follow the instructions above to disable the auto power shutoff parameter.

### (3) Resetting the low temperature alarm tolerance setting

This unique function alerts the operator when the sensed temperature falls below a set limit. If the sensed temperature drops below the alarm level, an error message **H-E** will be displayed, and the buzzer will sound. When the temperature returns within the allowable range, the buzzer will stop. The value is stored in the Hakko 941 as described in the example below:

**EXAMPLE:**

If the set temperature is 350°C. and the low temperature alarm is 100°C., the alarm will trip when the sensed temperature drops below 250°C.

**NOTE:**

The threshold limits are: 30°– 150°C.; 50°– 300°F.  
If a value exceeding these limits should be entered, the system will revert to the beginning of the mode (the hundreds digit will flash) and the procedure must be begun anew.

To bypass this procedure, press the **✖** button three times.

Range of allowable low-temperature alarm tolerance  
For °C: 30° – 150°C  
For °F: 50° – 300°F

### (4) Resetting the supervisor/operator control setting

- When the station enters low-temperature alarm tolerance setting mode, the hundreds digit begun flashing. Enter and store the value in the same manner as described in “Changing the temperature setting.”
- If you enter a value exceeding the allowable range shown to the left, you will be brought back to entering a value in the hundreds digit. If this occurs, re-enter a correct value.
- Once the value is stored, the system will automatically sequence to the resetting the supervisor/operator control setting.

To change the supervisor/operator control settings, the procedure is as follows.

- The display will show **4 0** or **4 1** when this mode is entered.  
**4 0** : No offset value can be entered without inserting the card.  
**4 1** : An offset value can be entered without inserting the card.

Pressing the **UP** or **DOWN** button will change **4 0** and **4 1**.

When the desired setting is displayed, select by pressing **✖** button.

The system will exit the parameter setting mode and begin heater control.

It is now ready for normal operation.

# 9. MAINTENANCE

---

## ● Tip maintenance

### 1. Tip temperature

High temperatures shorten tip life and may cause thermal shock to components. Always use the lowest possible temperature when soldering. The excellent thermal recovery characteristics of the Hakko 941 ensure effective soldering at low temperatures.

### 2. Cleaning

Always clean the soldering tip before use, to remove any residual solder or flux adhering to it. Use a *clean and moist* cleaning sponge (provided with the Hakko 941) or the Hakko 599 tip cleaner. Contaminants on the tip have many deleterious effects, including reduced heat conductivity, which contribute to poor soldering performance.

### 3. After use

Always clean the tip and coat it with fresh solder after use. This guards against oxidation.

### 4. When the unit is not being used and the auto power shutoff is not active.

Never allow the unit to idle at a high temperature for extended periods. This will allow the tip to become oxidized. Turn the power switch OFF. If it is to be out of service for several hours, it is advisable to pull the power plug as well.

### 5. Inspecting and cleaning the tip

This procedure, if followed daily, will materially add to tip life.

- a. Set the temperature to 250°C. (482°F.)
- b. When the temperature stabilizes, clean the tip (see 2, above) and check the condition of the tip. If the tip is badly worn or deformed, replace it.
- c. If the solder plated part of the tip is covered with black oxide, apply fresh solder, containing flux, and clean the tip again. Repeat until all the oxide is removed, then coat the tip with fresh solder.

<p><b>⚠ CAUTION:</b> NEVER file the tip to remove oxides!</p>
---

- d. Turn the power OFF and remove the tip, using the heat resistant pad. Set the tip aside to cool.
- e. Remaining oxides, such as the yellow discoloration on the tip shaft, can be removed with isopropyl alcohol.

## ● Checking Procedure

### ⚠ WARNING:

Unless otherwise directed, carry out these procedures with the power switch OFF and the power UNPLUGGED.

### ■ Check for a broken heater or sensor

1. Check for a broken heater or sensor

Measure the resistance across this position.

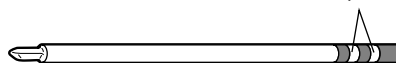

Verify the electrical integrity of the heater and sensor.

Measure the resistance of the heater and sensor while at room temperature (15 to 25°C.; 59 to 77°F.). It should be  $5\Omega \pm 10\%$ . If the resistance exceeds these limits, replace the tip.

### ■ Check the grounding line

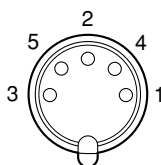

1. Unplug the connection cord from the station.
2. Measure the resistance value between Pin 2 and the tip.
3. If the value exceeds  $2\Omega$  (at room temperature), perform the tip maintenance described on p.12. If the value still does not decrease, check the connection cord for breakage.

### ■ Checking the connection cord for breakage

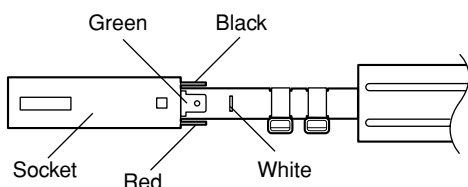

1. Remove the soldering tip and the nipple.
2. Push the socket out from inside the handle assembly.
3. Measure the resistance values between the connector and the lead wires at the socket as follows:
 

Pin 1 – Red	Pin 2 – Green
Pin 3 – Black	Pin 5 – White

 If any value exceeds  $0\Omega$  or is  $\infty$ , replace the handle assembly.

### ⚠ CAUTION:

Do not lose the O-ring located inside the nipple. When reassembling, match the convex part of the handle assembly with the concave parts of the O-ring spacer and socket.

### ■ Replacing the fuse

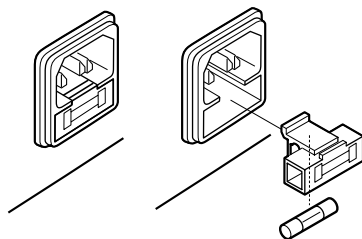

1. Unplug the power cord from the power receptacle.
2. Remove the fuse holder.
3. Replace the fuse.
4. Put the fuse holder back in place.

# 10. ERROR MESSAGES

## ● Sensor Error



When there is the possibility that a failure has occurred in the sensor or heater (including the sensor circuit), **S-E** is displayed and the power is shut down with the buzzer sounding continuously.

**⚠ CAUTION:**

The sensor error also occurs if the tip is not inserted properly. Once the tip is inserted properly, the HAKKO 941 is restarted.

## ● Low-temperature alarm tolerance error



If the sensor temperature falls below the difference between the current temperature setting and the low-temperature alarm tolerance, **H-E** is displayed and the warning buzzer sounds. When the tip temperature rises to a value within the set tolerance, the buzzer will stop sounding.

**EXAMPLE:**

Assume that the temperature setting is 400°C./750°F. and the tolerance 50°C./100°F. If the temperature continues to decrease and finally falls below the value indicated below while the heating element is on, the displayed value starts blinking to indicate that the tip temperature has dropped.

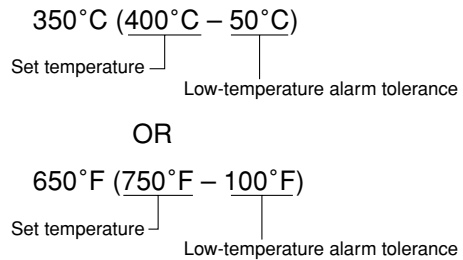

# 11. TROUBLE SHOOTING GUIDE

## WARNING:

- Before checking the inside of the Hakko 941 or replacing parts, be sure to disconnect the power plug. Failure to do so may result in electric shock.

### ● The unit does not operate when the power switch is turned on.

**CHECK** : Is the power cord and/or the connection plug disconnected?

**ACTION** : Connect it.

**CHECK** : Is the fuse blown?

**ACTION** : Investigate why the fuse blew and then replace the fuse. If the cause can not be determined, replace the fuse. If the fuse blows again, send the unit in for repair.

### ● The tip does not heat up.

- The sensor error **S-E** is displayed.

**CHECK** : Is the power cord and/or the connection plug disconnected?

**ACTION** : Connect it.

**CHECK** : Is the tip inserted properly?

**ACTION** : Insert the tip completely.

**CHECK** : Is the connection cord and/or the heater/sensor broken?

**ACTION** : See the appropriate section of this manual regarding how to check the connection cord and/or the heater/sensor for breakage.

### ● Solder does not wet the tip.

**CHECK** : Is the tip temperature too high?

**ACTION** : Set the appropriate temperature.

**CHECK** : Is the tip contaminated with oxide?

**ACTION** : Remove the oxide (see "Tip maintenance" on P. 12).

### ● The tip temperature is too high.

**CHECK** : Is the connection cord broken?

**ACTION** : See "Checking the connection cord for breakage" on P. 13.

**CHECK** : Is the entered offset value correct?

**ACTION** : Enter the correct value.

### ● The tip temperature is too low.

**CHECK** : Is the tip contaminated with oxide?

**ACTION** : Remove the oxide (see "Tip maintenance" on P. 12).

**CHECK** : Is the entered offset value correct?

**ACTION** : Enter the correct value.

### ● The low-temperature alarm tolerance error occurs frequently.

**CHECK** : Is the tip too small for the items to be soldered?

**ACTION** : Use a tip with a larger thermal capacity.

**CHECK** : Is the setting value for the low-temperature alarm tolerance too low?

**ACTION** : Increase the setting value.



# 12. PARTS LIST

**NOTE:**

Spare or repair parts do not include mounting screws, if they are not listed on the description. Screws must be ordered separately.

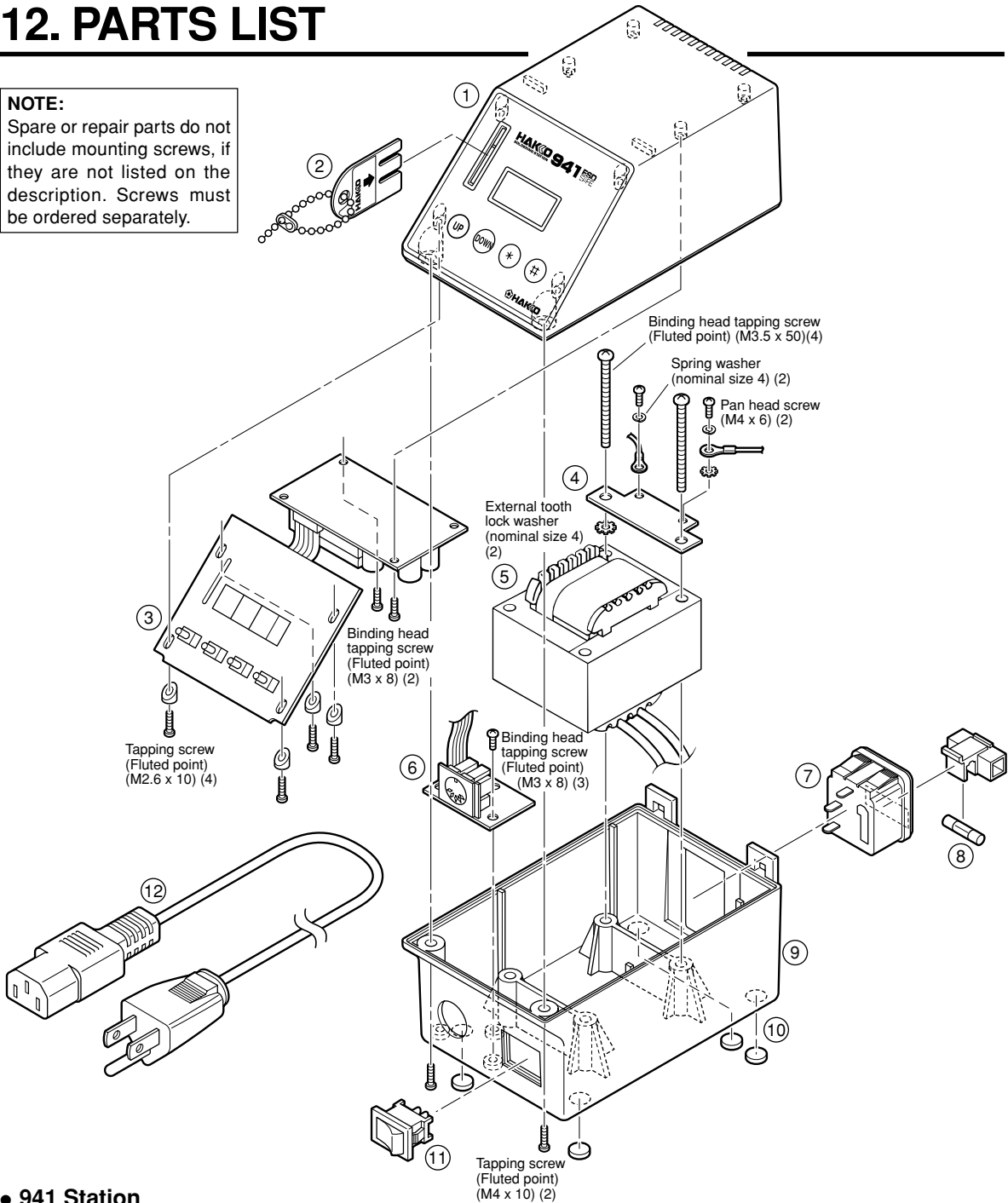

● 941 Station

Item No.	Part No.	Part Name	Description
1	B2568	Upper case	With membrane sheet
2	B2388	Control card	
3	B2569	P.W.B. (temperature control & power supply) – 2 pcs.	
4	B2664	Grounding plate	
5	B2570	Transformer	100-15V
	B2599	Transformer	110-15V
	B2590	Transformer	120-15V
	B2600	Transformer	220-15V
	B2591	Transformer	230-15V
	B2592	Transformer	230-15V (CE)
	B2594	Transformer	240-15V
6	B2383	Connector board	
7	B2666	Power receptacle	
8	B2403	Fuse, 250V-2A	100~120V
	B2404	Fuse, 250V-1A	220~240V

Item No.	Part No.	Part Name	Description
9	B2571	Bottom case	With power receptacle, rubber feet
10	B2667	Rubber foot	4 ea.
11	B2663	Power switch	
12	B2668	Power cord, 3 core & American plug	
	B2421	Power cord, 3 core, no plug	
	B2422	Power cord, 3 core, BS plug	India
	B2423	Power cord, 3 core, European plug	Korea
	B2424	Power cord, 3 core, European plug	Eur.
	B2425	Power cord, 3 core, BS plug	U.K.
	B2426	Power cord, 3 core, Australian plug	

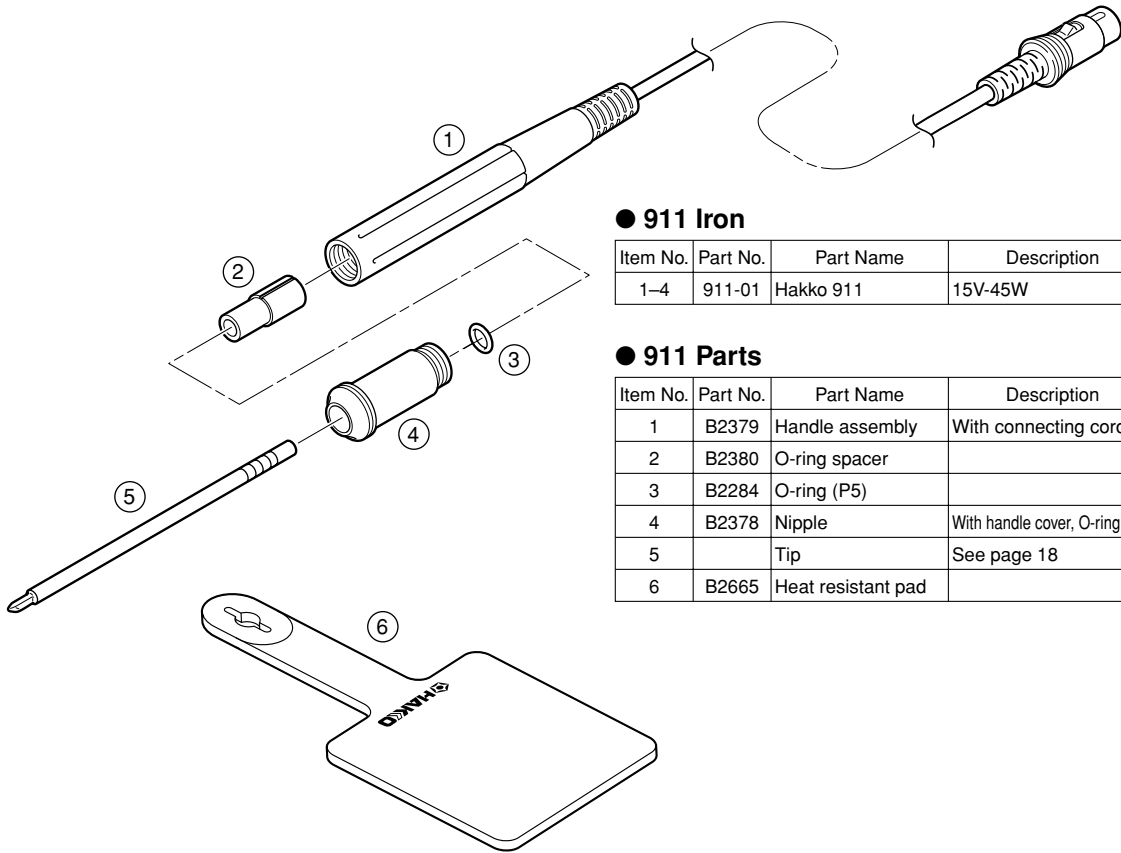

● 911 Iron

Item No.	Part No.	Part Name	Description
1-4	911-01	Hakko 911	15V-45W

● 911 Parts

Item No.	Part No.	Part Name	Description
1	B2379	Handle assembly	With connecting cord
2	B2380	O-ring spacer	
3	B2284	O-ring (P5)	
4	B2378	Nipple	With handle cover, O-ring (P5)
5		Tip	See page 18
6	B2665	Heat resistant pad	

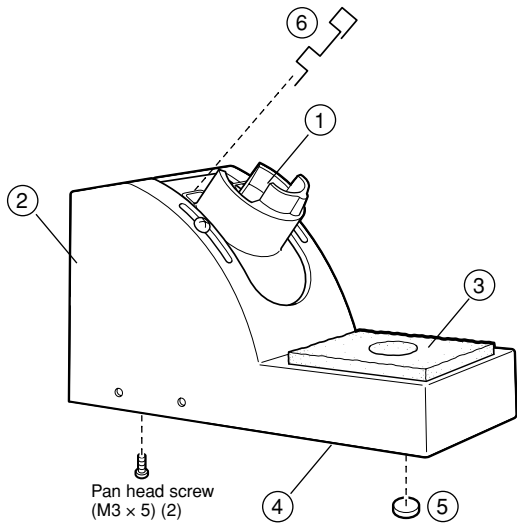

● Iron Holder

Item No.	Part No.	Part Name	Description
1-5	C1413	Iron holder	For HAKKO 911, 912

● Iron Holder Parts

Item No.	Part No.	Part Name	Description
1	B2390	Iron receptacle	With two screws
2	B2389	Iron holder base	(With bottom plate)
3	A1427	Cleaning sponge	
4	B2391	Bottom plate	
5	B2405	Rubber foot	4 ea.
6	B2572	Retaining clip	
7	B2607	Tip tray	

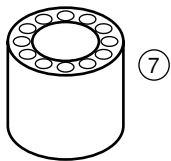

# 13. TIP STYLES

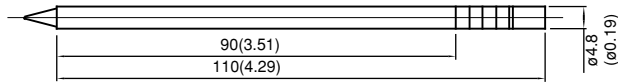

Unit: mm (in.)

T1-B Shape-B

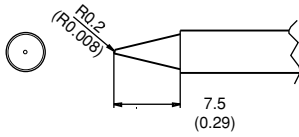

T1-08D Shape-0.8D

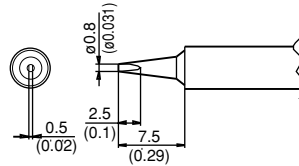

T1-12D Shape-1.2D

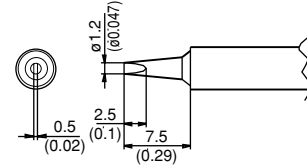

T1-16D Shape-1.6D

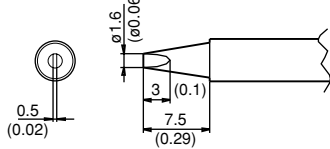

T1-24D Shape-2.4D

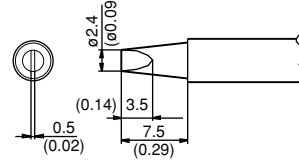

T1-4D Shape-4D

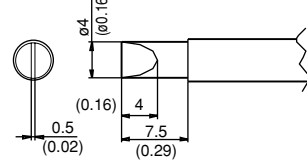

T1-1BC Shape-1BC

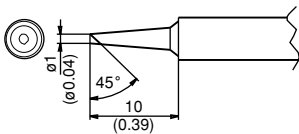

T1-2BC Shape-2BC

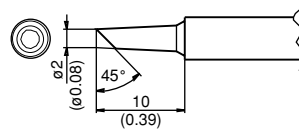

T1-3BC Shape-3BC

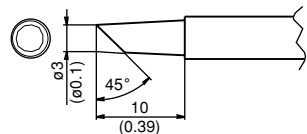

T1-4C Shape-4C

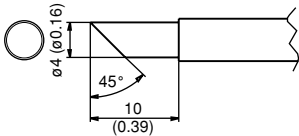

T1-1BCF Shape-1BC  
Cut Surface Pre-tinned

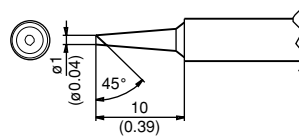

T1-2BCF Shape-2BC  
Cut Surface Pre-tinned

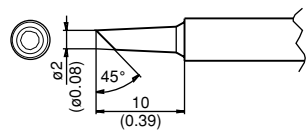

T1-3BCF Shape-3BC  
Cut Surface Pre-tinned

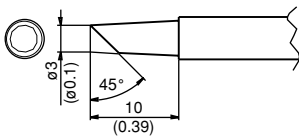

T1-4CF Shape-4C  
Cut Surface Pre-tinned

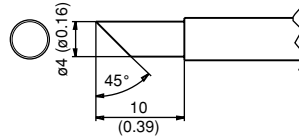

T1-LI Shape-LI

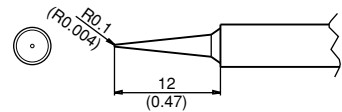

T1-LB Shape-LB

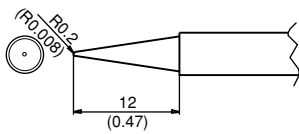

T1-02J Shape-0.2RB

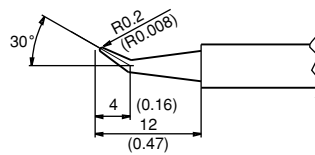

T1-I Shape-I

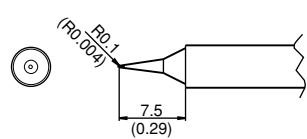

T1-K Shape-K

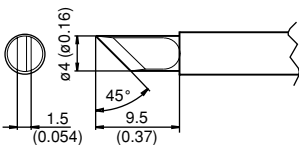

T1-KL Shape-KL

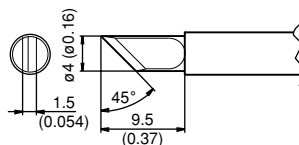

# 14. WIRING DIAGRAM

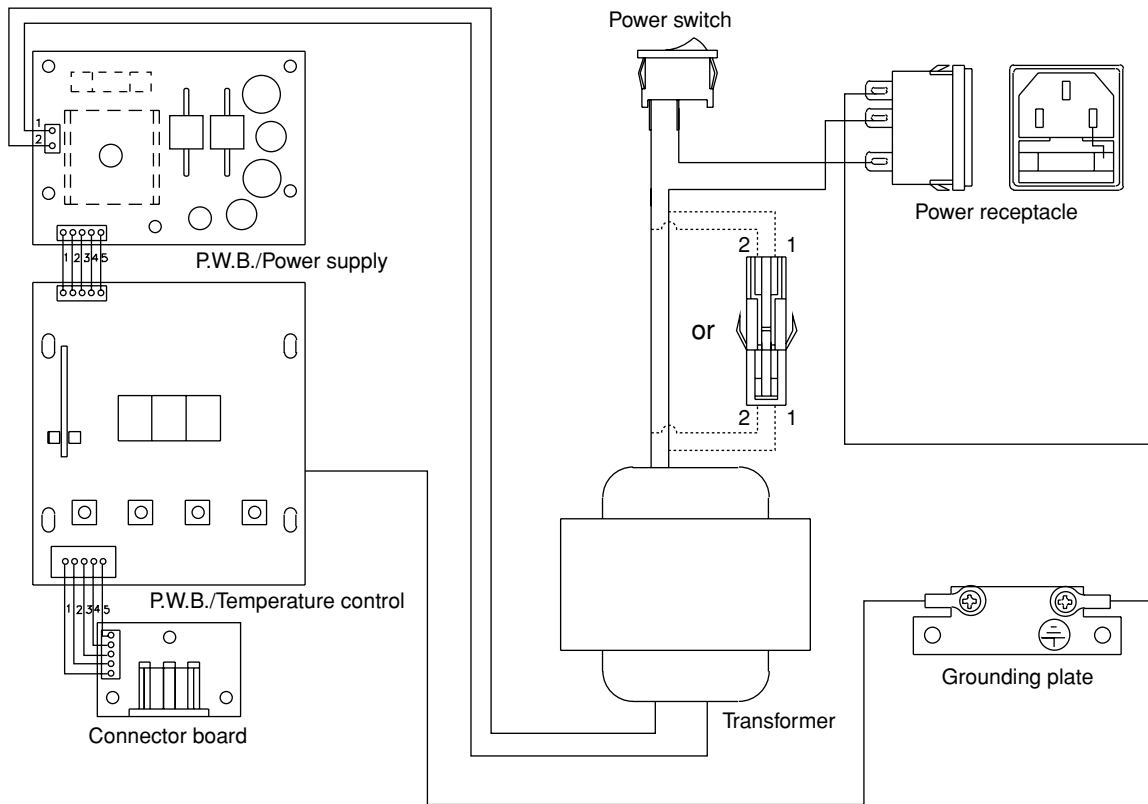

## OVERSEAS AFFILIATES

**U.S.A.: AMERICAN HAKKO PRODUCTS, INC.**  
25072 ANZA DR. SANTA CLARITA, CA 91355, U.S.A.  
TEL: (661) 294-0090 FAX: (661) 294-0096  
Toll Free (800)88-HAKKO

<http://www.hakkousa.com>

**HONG KONG: HAKKO DEVELOPMENT CO., LTD.**  
ROOM 1504, EASTERN HARBOUR CENTRE,  
28 HOI CHAK STREET, QUARRY BAY, HONG KONG.  
TEL: 2811-5588 FAX: 2590-0217

<http://www.hakko.com.hk/>

**CHINA: HAKKO DEVELOPMENT CO., LTD.**  
ROOM 1112-1115, 11 FLOOR, INTERNATIONAL BANK  
TOWER 191 DONGFENG ROAD WEST, GUANGZHOU  
510180, CHINA.  
TEL: (020)8135-0112, 8135-0113 FAX: (020)8135-0181

## HEAD OFFICE

4-5, SHIOKUSA 2-CHOME, NANIWA-KU, OSAKA, 556-0024 JAPAN  
TEL:+81-6-6561-3225 FAX:+81-6-6561-8466  
<http://www.hakko.com>

## TAIWAN: HAKKO DEVELOPMENT CO., LTD.

3F., NO 110, CHUNG HSIN RD., SEC.3, SANCHUNG, TAIPEI  
HSIEN, TAIWAN.

TEL: (02)2975-2600 FAX: (02)2973-9565

## SINGAPORE: HAKKO PRODUCTS PTE., LTD.

1, GENTING LINK #02-04, PERFECT INDUSTRIAL

BUILDING, SINGAPORE 349518

TEL: 748-2277 FAX: 744-0033

E-mail: sales@hakko.com.sg

## MALAYSIA: HAKKO PRODUCTS SDN BHD

NO.22, JALAN PEMBERITA U1/49, SEKSYEN U1,

TEMASYA INDUSTRIAL PARK, 40150 GLENMARIE,

SHAH ALAM, SELANGOR DARUL EHSAN, WEST MALAYSIA.

TEL: (03)519-5223 FAX: (03)519-5221

E-mail: hakkokl@tm.net.my

**PENANG BRANCH:** TEL: (04)507-0888 FAX: (04)507-0999

**JOHORE BAHRU BRANCH:** TEL: (07)236-7766 FAX: (07)237-4655

## PHILIPPINES: HAKKO PHILS TRADING CO., INC.

NO. 415 WINDSOR TOWER CONDOMINIUM,  
163 LEGASPI ST., LEGASPI VILLAGE MAKATI,

METRO MANILA, PHILIPPINES

TEL: (02)817-0712, 815-4993 FAX: (02)810-7649

E-mail: hakkophil@pacific.net.ph

## INDONESIA: P.T. HAKKO PRODUCTSTAMA INDONESIA

COMP BUMI INDAH BLOK IV NO. 40 NAGOYA BATAM, INDONESIA.

TEL: (778)457-459 FAX: (778)452-772

E-mail: hakkobtm@indosat.net.id

## P.T. HAKKO PRODUCTSTAMA INDONESIA

KEBON JERUK PLAZA, BLOK D NO. 6, JALAN RAYA PERJUANGAN,

JAKARTA BARAT, JAKARTA 11530, INDONESIA.

TEL: (21)532-4083 FAX: (21)532-4082

E-mail: hakkokjt@cbrn.net.id